



## Product Features

- Super Slim liner LED with high output
- Quick connection system between fixtures
- Many lengths available
- Various mounting methods including magnetic
- To be used with constant voltage DC 24V driver
- Dimmable with available accessories

## Specification

- Voltage : DC 24V
- Operating temperature : 0~45° C
- Lamp life : 40,000hr/70%
- Available color : 4000K
- Color rendering : Ra > 80
- Energy efficiency : 75 lm/W
- Degree of protection IP20

## DIVA 2 HO

High Output



Diva2 HO 3W Length (145 mm)



Diva2 HO 6W Length (285 mm)



Diva2 HO 12W Length (565 mm)



Diva2 HO 18W Length (845 mm)



Diva2 HO 24W Length (1123mm)

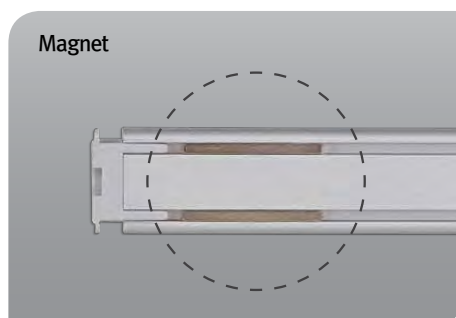

**Various options**

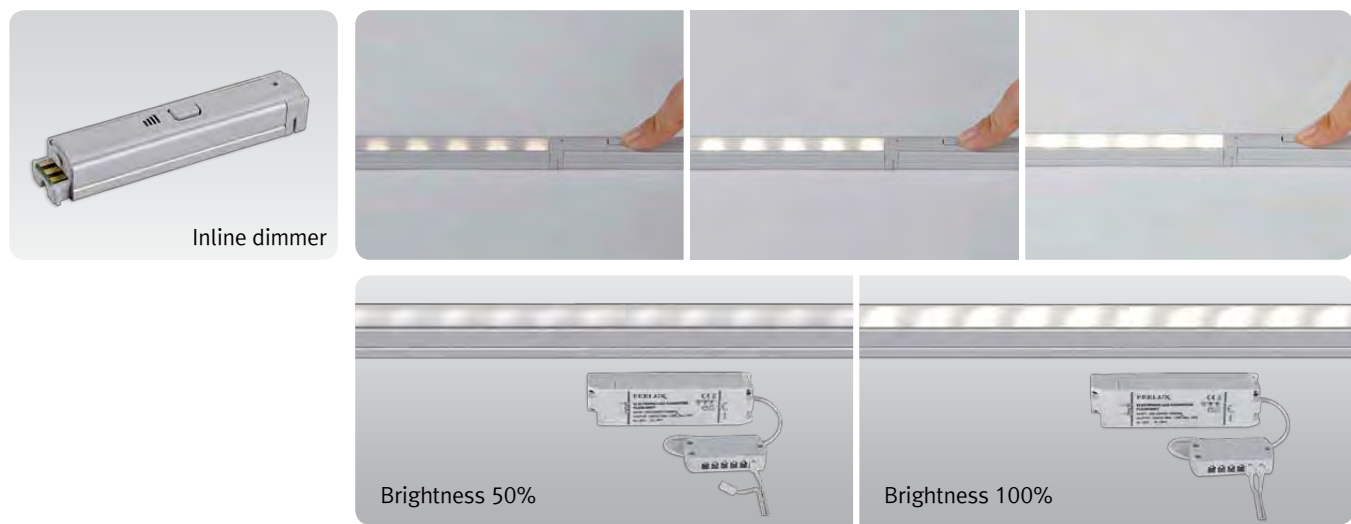

**Dimension**

\* Fixture

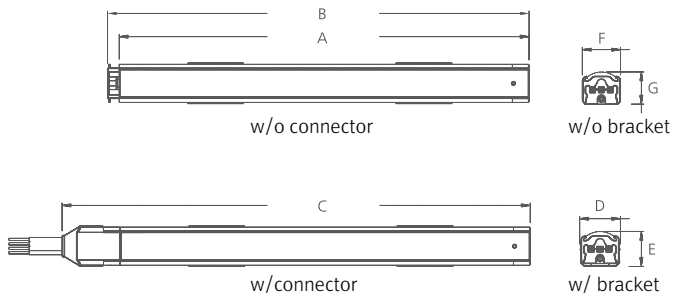

Model Name	Power Input (V)	Lamp Power (W)	A (mm)	B (mm)	C (mm)	D (mm)	E (mm)	F (mm)	G (mm)
DIVA230NHO	DC 24	2.9	140	145	162	16	14	15	12.5
DIVA300NHO	DC 24	5.8	280	285	302	16	14	15	12.5
DIVA600NHO	DC 24	11.6	560	565	582	16	14	15	12.5
DIVA900NHO	DC 24	17.4	840	845	862	16	14	15	12.5
DIVA1100NHO	DC 24	23.2	1118	1123	1140	16	14	15	12.5

\* Inline dimmer

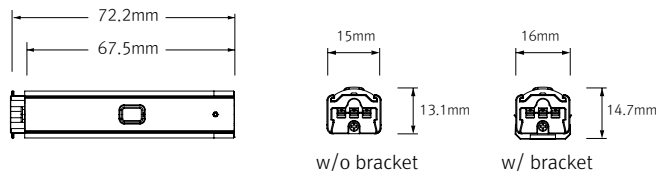

**Easy connection**

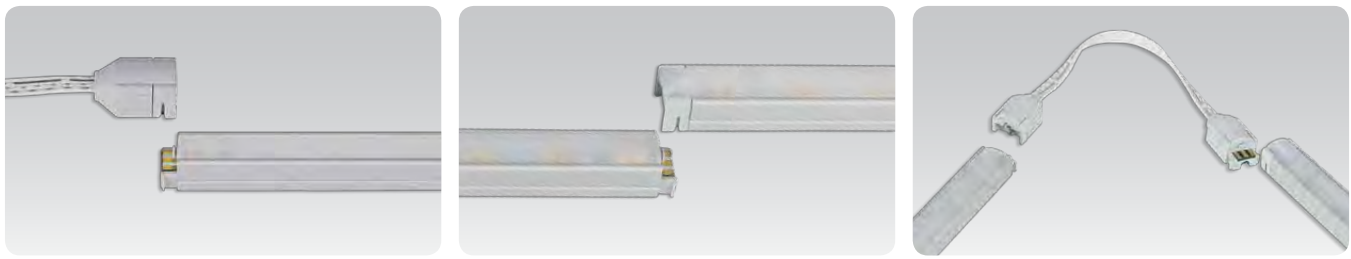

**M12 - Anschlußkabel**

Artikel-Nummer	Bezeichnung	Länge
D AK-HO-200-M12	Anschl. Kabel mit M12 Pigtail	200 mm



**Installation**

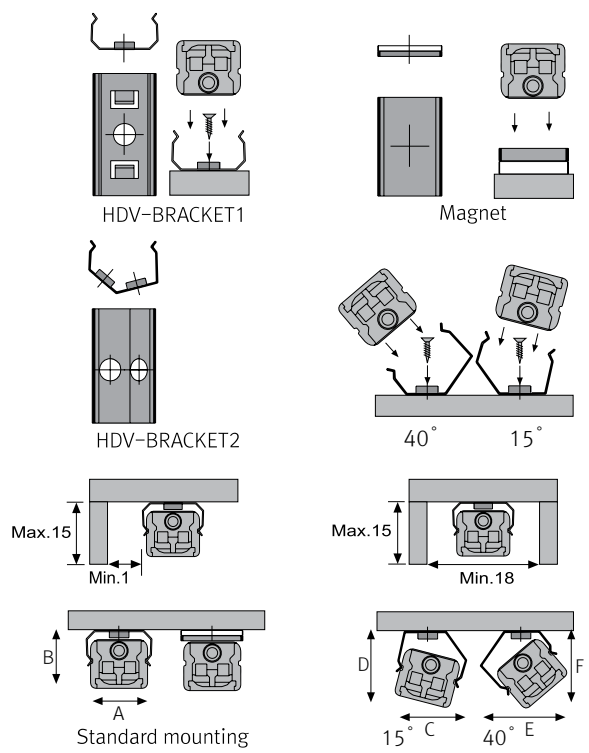

**Max. connection**

- DIVA2 HO : 75Watt in one row (single power feed)
- LED Driver

LED Driver Model Name	Max. units for LED Driver		
	24V/15W	24V/30W	24V/75W
DIVA 230N HO	5	10	25
DIVA 300N HO	2	5	12
DIVA 600N HO	1	2	6
DIVA 900N HO	-	1	4
DIVA 1100N HO	-	1	3

	A(mm)	B(mm)	C(mm)	D(mm)	E(mm)	F(mm)
DIVA 2 HO	16,8	14,2	17,5	16,5	19,1	17,5

## Accessories

### Ⓐ Connecting cables (Between DIVA2 HO & DIVA2 HO)

DVKHO-150	DVKHO-300	DVKHO-600	DVKHO-1200	DVKHO-1800
150mm(6inch)	300mm(1feet)	600mm(2feet)	1200mm(4feet)	1800mm(6feet)

### Ⓑ Power feed : D AK-HO-025

Power feed 2500mm (Between DIVA2 HO & 6-way distributor)

### Ⓒ Mounting bracket : DV2HO-CLIP

Included in fixture

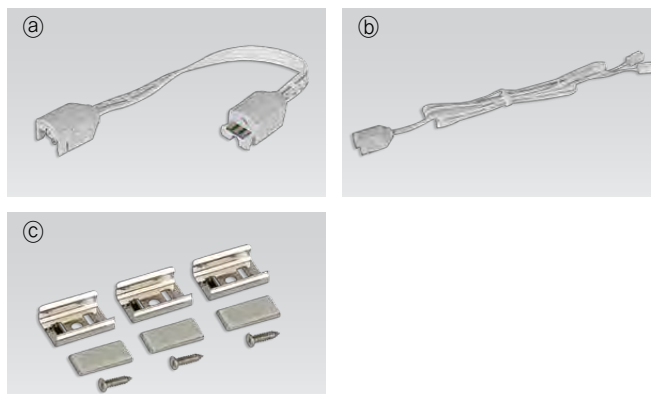

## M12 - Anschlußkabel

Artikel-Nummer	Bezeichnung	Länge
D AK-HO-200-M12	Anschl. Kabel mit M12 Pigtail	200 mm



## Anschluß-Belegung

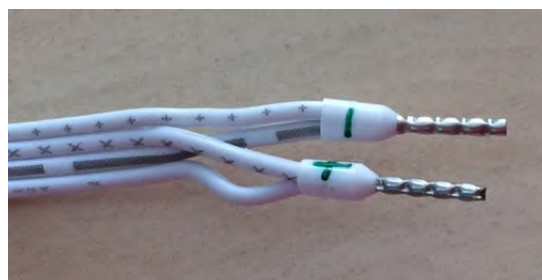



## Product Features

- Super Slim liner LED with standard output
- Quick connection system between fixtures
- Many lengths available
- Various mounting methods including magnetic
- To be used with constant voltage DC 24V driver
- Dimmable with available accessories

## Specification

- Voltage : DC 24V
- Operating temperature : 32~113F(0~45° C)
- Lamp life : 40,000hr/70%
- Available color : 2400K, 2700K, 3000K, 3500K, 4000K, 6000K
- Color rendering : Ra > 85
- Energy efficiency : 75lm/W
- Degree of protection IP20

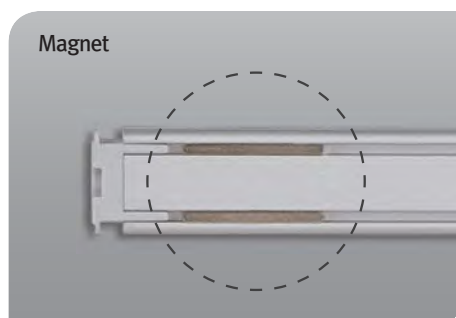

**FLX Stix HDV**

High Output



FLX Stix HDV 3W (5  $\frac{45}{64}$ " )



FLX Stix HDV 6W (11  $\frac{7}{32}$ " )



FLX Stix HDV 12W (22  $\frac{1}{4}$ " )



FLX Stix HDV 18W (33  $\frac{17}{64}$ " )



FLX Stix HDV 24W (44  $\frac{7}{32}$ " )

Various options



Inline dimmer

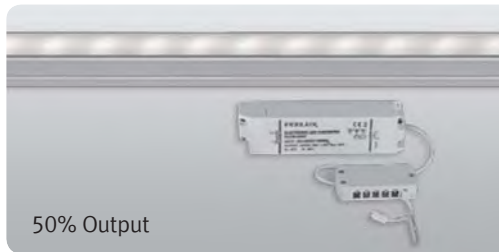

50% Output



100% Output

Easy connection

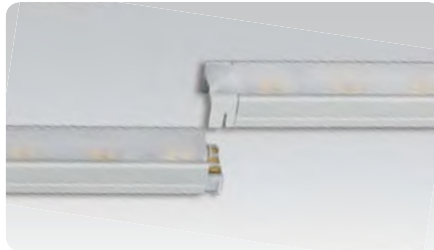
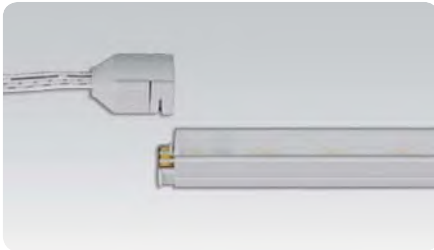

Dimension

\* Fixture

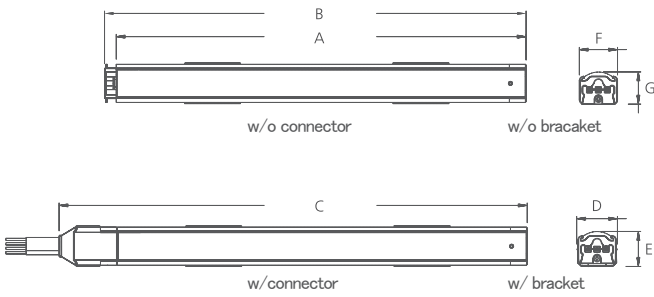

Model Name	Power Input (V)	Lamp Power (W)	A (mm)	B (mm)	C (mm)	D (mm)	E (mm)	F (mm)	G (mm)
HDV3-[Color]K-24V	DC 24	2.9	140	145	162	16	14	15	12.5
HDV6-[Color]K-24V	DC 24	5.8	280	285	302	16	14	15	12.5
HDV12-[Color]K-24V	DC 24	11.6	560	565	582	16	14	15	12.5
HDV18-[Color]K-24V	DC 24	17.4	840	845	862	16	14	15	12.5
HDV24-[Color]K-24V	DC 24	23.2	1118	1123	1140	16	14	15	12.5

\* Fixture with round diffuser

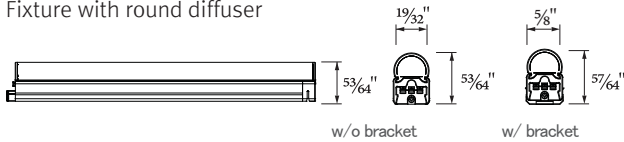

\* Fixture with square diffuser

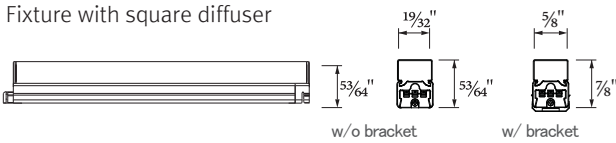

\* Inline dimmer

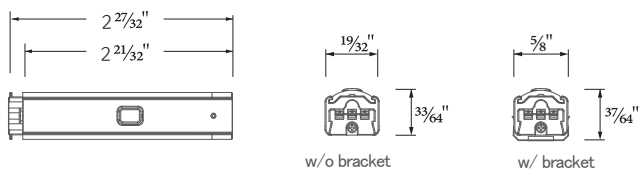

\* LED Converter

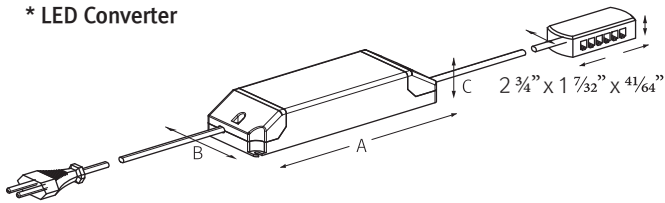

Model Name	A (mm)	B (mm)	C (mm)
FLC15-24V/XL	121	45	16
FLC30-24V/XL	150	41	31
FLC75-24V/XL	180	60	32

Installation

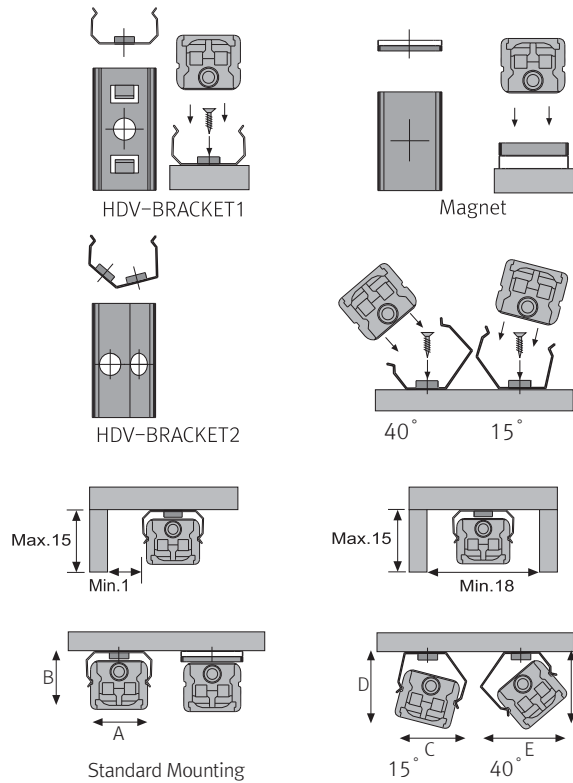

Max. connection

- FLX Stix HDV : 75Watt in one row (single power feed)
- LED Driver

LED Driver Model Name	Max. units for LED Driver		
	24V/15W	24V/30W	24V/75W
HDV3-[Color]K-24V	5	10	25
HDV6-[Color]K-24V	2	5	12
HDV12-[Color]K-24V	1	2	6
HDV18-[Color]K-24V	-	1	4
HDV24-[Color]K-24V	-	1	3

	A(mm)	B(mm)	C(mm)	D(mm)	E(mm)	F(mm)
Flat type	16.8	14.2	17.5	16.5	19.1	17.5
Round type	16.8	22.1	18.8	24.4	23.4	22.9
Square type	16.8	22.6	21.3	26.2	25.7	25.7

Accessories

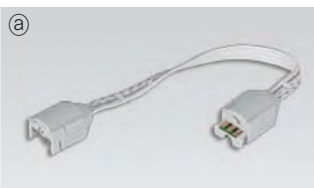

Ⓐ Connecting Cables (Between FLX Stix HDV & FLX Stix HDV)

HDVPTC	HDVPTC1	HDVPTC2	HDVPTC4	HDVPTC6
5 <sup>29</sup> / <sub>32</sub> "	11 <sup>13</sup> / <sub>16</sub> "	23 <sup>5</sup> / <sub>8</sub> "	47 <sup>1</sup> / <sub>4</sub> "	70 <sup>55</sup> / <sub>64</sub> "



Ⓑ Power feed : HDVPC

Power feed 98 <sup>27</sup>/<sub>64</sub>" (Between FLX Stix HDV & 6-way distributor)





© Mounting Bracket : HDV-BRACKET1

Included in fixture



© Angle Bracket (15 & 40) : HDV-BRACKET2



© Sidefeed for seamless extension (3W) : HDV3-[Color]K-24V-S

The dimension is the same as HDV3-[Color]K-24V



① End cap : HDV-END-CAP

Included in fixture



© LED Driver with 6way distributor, with power feed(70<sup>55/64</sup>)

Part No	FLC15-24V/XL	FLC30-24V/XL	FLC75-24V/XL
Capacity	15W 24V	30W 24V	75W 24V



© Dimming Interface (1-10V) : FDC-L10 (Max.100W)



① Inline Dimmer : HDVDIM (Max 75W in a row)



① Round Diffuser

HDV-3W-RM	HDV-6W-RM	HDV-12W-RM	HDV-18W-RM	HDV-24W-RM
3W	6W	12W	18W	24W



© Square Diffuser

HDV-3W-SM	HDV-6W-SM	HDV-12W-SM	HDV-18W-SM	HDV-24W-SM
3W	6W	12W	18W	24W



① Connecting Bracket : HDV-BRACKET3

Included in fixture